

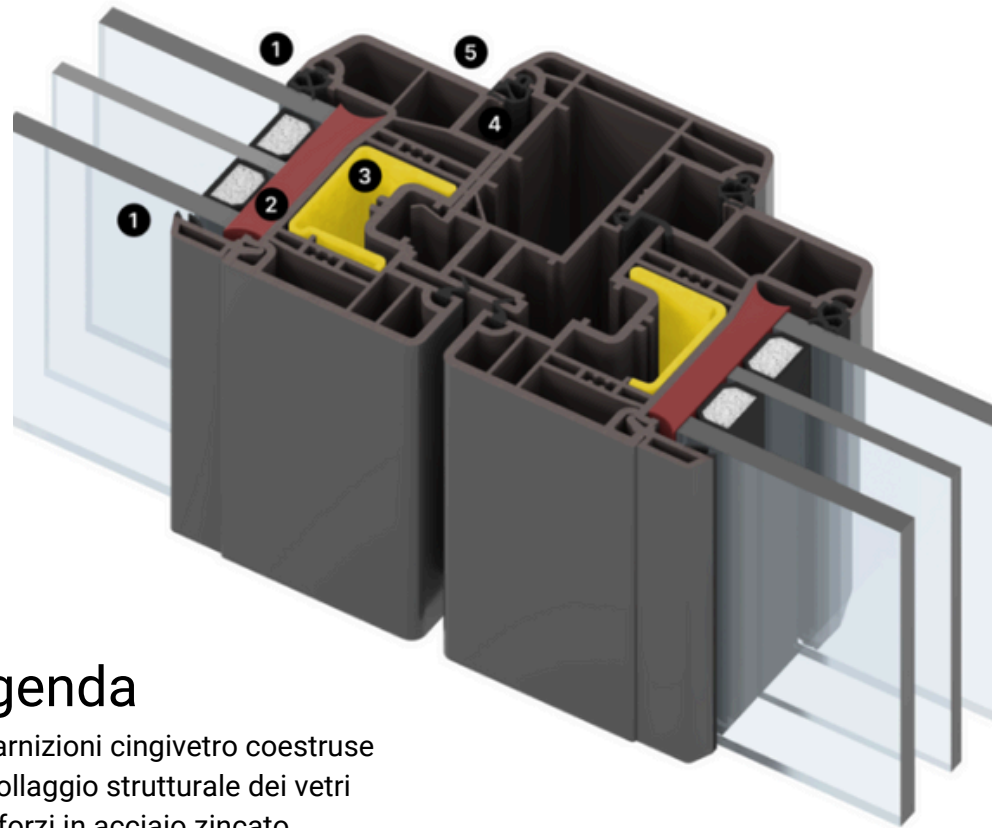

PERFORMANCE 86

DS DIMENSIONE[®]
SERRAMENTI

NODO CENTRALE



Legenda

1. Guarnizioni cingivetro coestruse
2. Incollaggio strutturale dei vetri
3. Rinforzi in acciaio zincato
4. Tripla guarnizione coestrusa per una tenuta eccellente
5. Profilo anta sagomato

Caratteristiche tecniche

PROFILATI estrusi PVC	REHAU RAU-FIPRO-X
Tipo di tenuta aria acqua vento	Tripla guarnizione
Resistenza all'effrazione	Sino a RC2
Applicazioni vetro	Con fermavetro a taglio 45°
Camera per vetro	Variabile sino a 53mm

Prestazioni generali

Isolamento termico

calcolato su finestra a 1 anta 800 x 1500 con vetro $U_g = 0,7$ (interc. caldo) $U_w = 0,8 \text{ W/m}^2\text{K}$

Permeabilità all'aria

CLASSE 4

Tenuta all'acqua

E900 Finestre-9A Porte finestre

Resistenza al carico del vento

C5/B5

Isolamento acustico

fino a 47 dB





Se intendete sostituire i vostri vecchi serramenti con un prodotto assolutamente innovativo che offre elevati valori di isolamento termo-acustico, DS_PERFORMANCE è il profilo finestra che fa per voi!

Dal punto di vista energetico, DS_PERFORMANCE è il miglior profilo finestra con profondità di 86 mm mai esistito sul mercato. Può vantare infatti valori di isolamento termico U_f previsti dallo standard per case passive fino a $0,85 \text{ W/m}^2\text{K}$, con conseguente risparmio sui costi di riscaldamento.

Le sue eccezionali proprietà soddisfano requisiti statici finora irraggiungibili e ciò si traduce in finestre dalle linee slanciate (115 mm di ingombro architettonico) che possono raggiungere dimensioni fino ad oggi proibitive. PERFORMANCE genera dunque nuove possibilità architettoniche, poiché è il primo profilo con armatura piena senza rinforzi in acciaio che permette di realizzare finestre dalle forme più diverse.

Linee estetiche disponibili

Poiché anche l'occhio vuole la sua parte, le finestre non devono essere solo funzionali, ma anche belle. Le finestre realizzate con profili DS PERFORMANCE 86 sono disponibili in un'ampia gamma di colori e con diverse varianti di profilo anta per scegliere lo stile che meglio si abbina alla vostra abitazione.

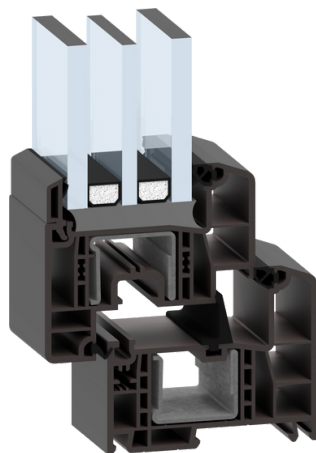

LINEA FLAT
(ANTA RIENTRATA E
FERMAVETRO INCLINATO)

Giunzioni profilo disponibili sul lato interno del serramento

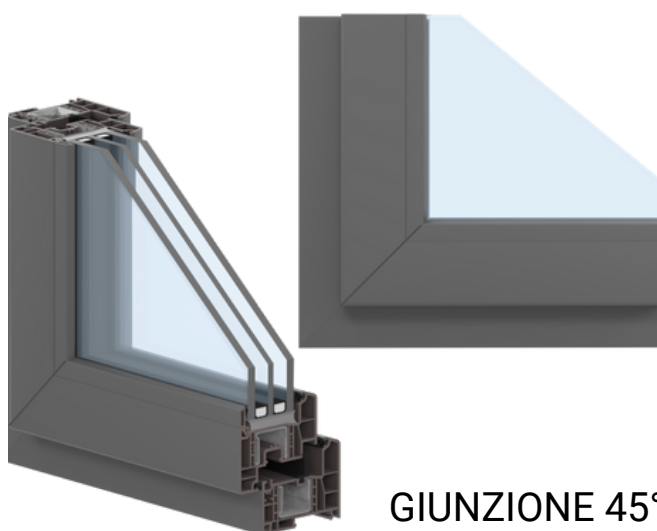

GIUNZIONE 45°

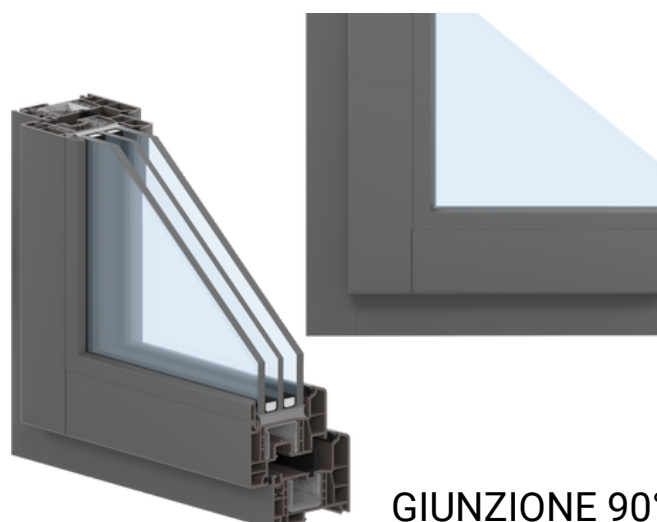

GIUNZIONE 90°

Più di 40 colori

Oltre 40 colori tra cui scegliere, forme particolari realizzabili senza alcun problema, possibilità di differenziare la finitura interna da quella esterna creando il tuo serramento bicolore: con i profili DIMENSIONE SERRAMENTI è possibile liberare la fantasia, creare il proprio stile, trasformare la finestra in un elemento che arreda. Indipendentemente dal colore, la finestra manterrà il suo aspetto inalterato nel tempo perchè i profili REHAU resistono agli agenti atmosferici e i colori rimangono stabili nel corso degli anni.



7774 Frassino

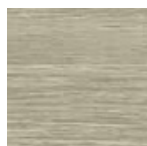

1562L Sheffield
Rovere Light

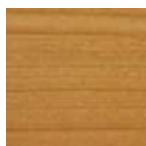

1423L Pino Nudo

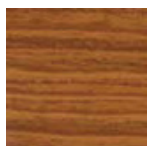

4404 Douglas

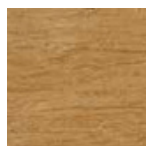

2013L Quercia
irlandese

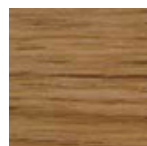

1208L Winchester XA

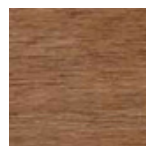

1991L Noce
Kolonial

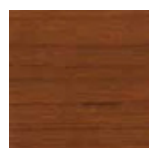

2014L Ciliegio soft

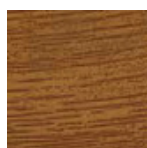

7512 Rovere gold

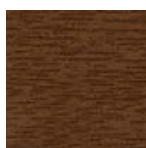

225L Noce

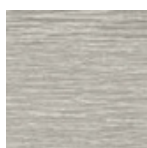

2038L Sheffield
Oak Alpine

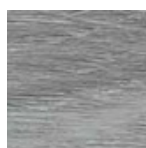

2039L Sheffield
Oak Concrete

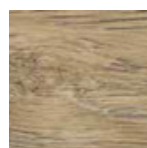

2031L Turner
Oak Malt

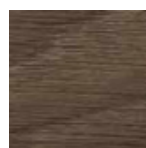

2451L Turner Oak
Toffee

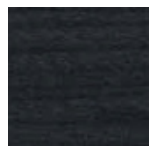

2521L Kitami Dark



2426L Pepper Oak
Super-Matt

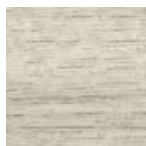

2532L Weissbach
Eiche Super-Matt

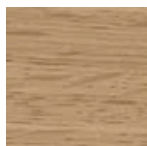

2533L Ginger Oak
Super-Matt

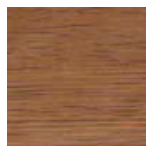

2534L Cinnamon
Oak Super-Matt

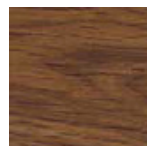

2366L Honey Oak
Super-Matt

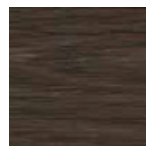

2535L Amaranth
Oak Super-Matt



2536L Verkehrsweiss

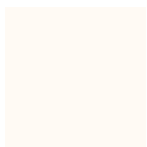

1551L Crema
Matt



2537L Quarzgrau



2538L Umbragrau

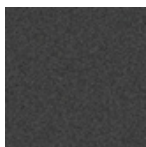

2539L S-Bronze

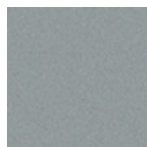

2540L Fenster Grau



2541L Basalt Grau

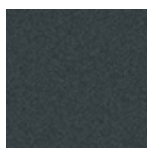

2542L Anthrazit Grau



1560L Grigio
Scuro Matt

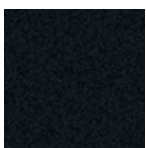

2543L Jet Black



9734 Bianco latte

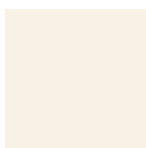

4444 Crema

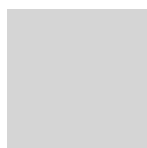

7666 Grigio chiaro



1049L Metbrush
Aluminium



9922 Grigio argento



4443 Grigio
antracite



1443L Bronzo



4683 Blu brillante



4925 Verde muschio



9773 Verde scuro



9792 Rosso scuro

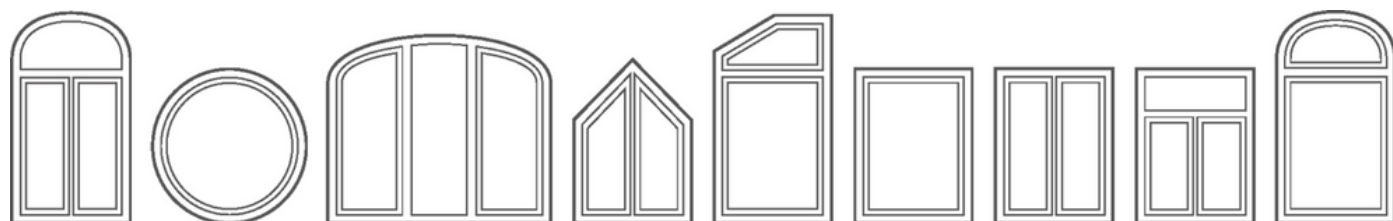



Dimensioni base del sistema

Telaio	sez. 86 mm
Anta	sez. 86 mm
Aletta di battuta a muro	0/40 mm

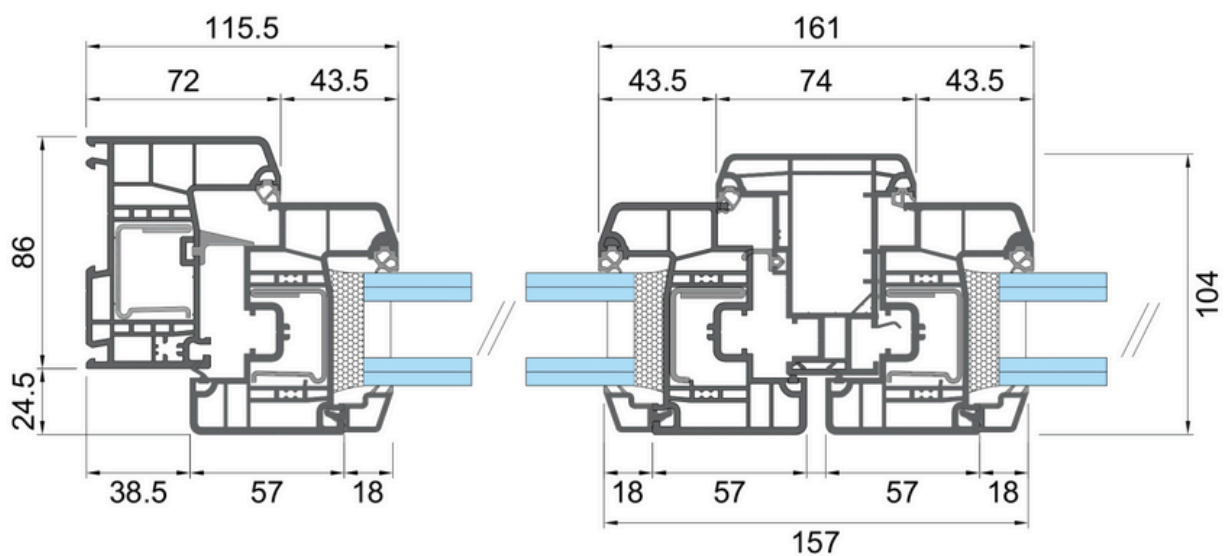



Eccellenza artigianale italiana per finestre su misura

Finestre italiane: perfezione su misura

Le finestre Made in Italy DS sono prodotte da esperti serramentisti che dedicano la massima cura e attenzione ai dettagli, offrendo soluzioni personalizzate e servizi di alta qualità. I professionisti qualificati DS forniscono consulenza, effettuano sopralluoghi, garantiscono un'installazione impeccabile e offrono un servizio di assistenza post-vendita.

Sede Produttiva

Via Serra, 6
40012 Calderara di Reno (BO)
Tel. 051/6468445
info@dimensioneserramenti.com

Showroom Bologna

Via Degli Orti 38/D
40137 Bologna
Tel. 051/6231186
bolognapoint@dimensioneserramenti.com

Showroom Casalecchio

Via Porrettana 281 (Rotonda Biagi)
40033 Casalecchio di Reno
Tel. 051/6131779
casalecchiopoint@dimensioneserramenti.com

Showroom Singapore **Deluxe Systems Pte Ltd**

National Design Centre
111 Middle Rd #03-01
Singapore 188969
Info@ds.asia – www.ds.asia

